

Mag 5/7e System

Manual



Underground Magnetics

www.undergroundmagnetics.com

Contents of MAG 7

1: Introduction	1
2: Caution	2
3: FCC Compliance Statement	3
4: Tips for Reading this Manual	4
5: Preface	5
6: System Highlights	7
7: Receiver	8
7.1: Specifications.....	8
7.2: Receiver Operation.....	8
7.3: Icons.....	9
7.3.1: Main Page Icons.....	9
7.3.2: Secondary Page Icons.....	11
7.3.3: Calibrations and Depth Forecast Page Icons.....	12
7.3.4: Setup Page Icons.....	12
7.4: Calibration.....	13
7.4.1: Depth Calibration.....	13
7.4.2: Roll Calibration.....	14
7.5: Operation.....	15
7.5.1: Depth Forecasting.....	15
7.5.2: Transmitter Activation.....	17
7.5.3: Transmitter Settings.....	18
7.5.4: Receiver Settings.....	19
7.5.5: Radio Channel Selection.....	20
7.5.6: Pairing.....	21
7.5.7: Pitch Unit Selection.....	22
7.5.8: Time Setting.....	23
7.5.9: System Unlock.....	24
7.5.10: Visibility Control.....	25
7.5.11: Speed Control.....	26
7.6: Receiver Maintenance.....	27

8: Display	28
8.1: Specifications.....	28
8.2: Display Operations.....	28
8.3: Icons.....	29
8.3.1: Main Page Icons.....	29
8.3.2: Secondary Page Icons.....	30
8.3.3: Setup Page Icons.....	30
8.3.4: Down Hole Echo Mode Change.....	31
8.3.5: Radio Channel Selection.....	33
8.3.6: Pairing.....	34
8.3.7: Pitch Unit Selection.....	35
8.3.8: Visibility Control.....	36
8.4: Display Maintenance.....	37
9: Transmitter	38
9.1: Introduction.....	38
9.2: Specifications.....	38
9.3: Digital Information.....	42
9.4: Transmitter Maintenance.....	42
10: Locating Methods	43
10.1: Locating Basics.....	43
10.1.1: Locate Points and Locate Line.....	43
10.1.2: Finding the Front Locate Point.....	45
10.1.3: Finding the Rear Locate Point.....	47
10.1.4: Finding the Locate Line and Transmitter.....	48
10.2: Tracking on the Fly.....	50
10.3: Bore-To.....	52
11: Battery and Charger	54
12: Warranty	54

1: Introduction

The MAG 7 is a locating system designed to assist horizontal directional drill machine operators in locating and tracking underground drill head locations and orientations. The system consists of a **transmitter**, a **receiver**, and a remote **display**.



The **transmitter** sends digital information of the transmitter's pitch, roll, temperature, and battery status through an FM modulated RF signal.



The **receiver** receives this information and uses RF signal to identify the transmitter's status and location.









The receiver transmits the locating information to a remote **display** through a radio telemetry system. A horizontal directional drill machine operator can use the information from the display to guide the drill head to the desired path.



This locating system also offers four channel license free radio telemetries between the receiver and remote display. The user can easily “pair” any two receivers and displays so that communications between the “pair” will not be interfered by other “pairs”.

This manual is intended to provide information and instructions on how to use this locating system properly. Underground Magnetics Inc. (UM) reserves the right to improve the locating system and the Operator's Manual at any time without notice.

2: Caution

-  The operator must understand safety procedures and correct operation methods before operating the HDD and the locating system.
-  HDD machines can cause property damage and personal injury upon striking underground power lines, gas lines, phone lines, television cables, fiber optic cables, or sewage lines. Make sure to confirm and mark all underground utilities before beginning operations.
-  Do not use the locating system near flammable or explosive substances.
-  Wear proper personal protective equipment including steel-toed boots, safety gloves, helmets, reflective vests, and safety goggles.
-  Obey all local safety regulations.
-  This locating system is only a tool to assist the operator to locate the drill head. It is the operator, not the Mag 7 locating system that is responsible for identifying the drill head location. UM is not responsible for any damage or loss caused by using the Mag 7 system. Operators should operate the Mag 7 system according to the manual.
-  If there are any questions, please contact UM at **support@undergroundmagnetics.com** or call customer service at **515-505-0960**.

3: FCC Compliance Statement

- This device complies with Part 15 of the FCC Rules. Operation is subject to the following two conditions:
 - This device may not cause harmful interference, and
 - This device must accept any interference received, including interference that may cause undesired operation.

- Changes or modifications not expressly approved by Underground Magnetics Inc. will void the user's authority to operate the equipment.

- Note: This product has been tested and found to comply with the limits for a Class B digital device, pursuant to Part 15 of the FCC Rules. These limits are designed to provide reasonable protection against harmful interference in a residential installation. This product generates, uses, and can radiate radio frequency energy and, if not installed and used in accordance with the instructions, may cause harmful interference to radio communications. However, there is no guarantee that interference will not occur in a particular installation. If this product does cause harmful interference to radio or television reception, which can be determined by turning the equipment off and on, the user is encouraged to try to correct the interference by one or more of the following measures:
 - Reorient or relocate the receiving antenna.
 - Increase the separation between the equipment and receiver.
 - Connect the equipment into an outlet on a circuit different from that to which the receiver is connected.
 - Consult the dealer or an experienced radio/TV technician for help.

4: Tips for Reading this Manual

Here are some points to keep in mind as you read through the Mag 7 Operator's Manual.

Page References

This question mark and textbox will tell you the page in the Operator's Manual where you can find more detailed information on the corresponding topic.



- The following two pages contain a short preface. This will be a quick introduction to the steps in which you will most likely use your Mag 7 System. It will also contain page references for the later sections of the manual that contain more detailed information for the corresponding steps.
- The rest of the manual will contain detailed sections that follow the order of the Mag 7 Receiver and Mag D6 menu screens.
- It is recommended to read the whole Operator's Manual first. Then use the separate Quick Start Guide, which is included with your system, as reference when needed.

5: Preface

When you receive your Mag 7 System the transmitter will have already been activated, preprogrammed at 19 kHz, and paired and calibrated with the receiver. The receiver and display will have been paired and set to channel 1.

1 Turn on receiver by holding power button until Mag 7 logo is visible on screen.



Page 8

2 Walk bore-path and use depth forecasting to check for interference and select frequency.



Page 16

3 Install batteries into transmitter. Install battery cap with provided battery cap tool.



Page 42

4 Turn on display by holding power button until Mag 7 logo is visible on screen.



Page 28

5 Install transmitter into the housing.

6 Check calibration by placing receiver 10ft away from housing, measured from inside edge of receiver to center of housing.



Page 13

7 If distance on receiver's screen reads anything other than 10ft, perform calibration.



Page 13

8 Begin drilling.

9 Locate FLP (Front Locate Point).



Page 45

10 Locate RLP (Rear Locate Point).



Page 47

11 Locate LL (Locate Line).



Page 48

Repeat steps 9 through 11 as you continue to guide drill.

6: System Highlights

- High precision and high anti-interference Faraday shield 3D antenna structure
- Industrial rated, gold-plated electronic modules
- High-performance DSP
- Dual locating system, functioning as two receivers independently tracking to provide better accuracy and reliability
- Up to 55 meters depth range and up to 160 hours continuous usage

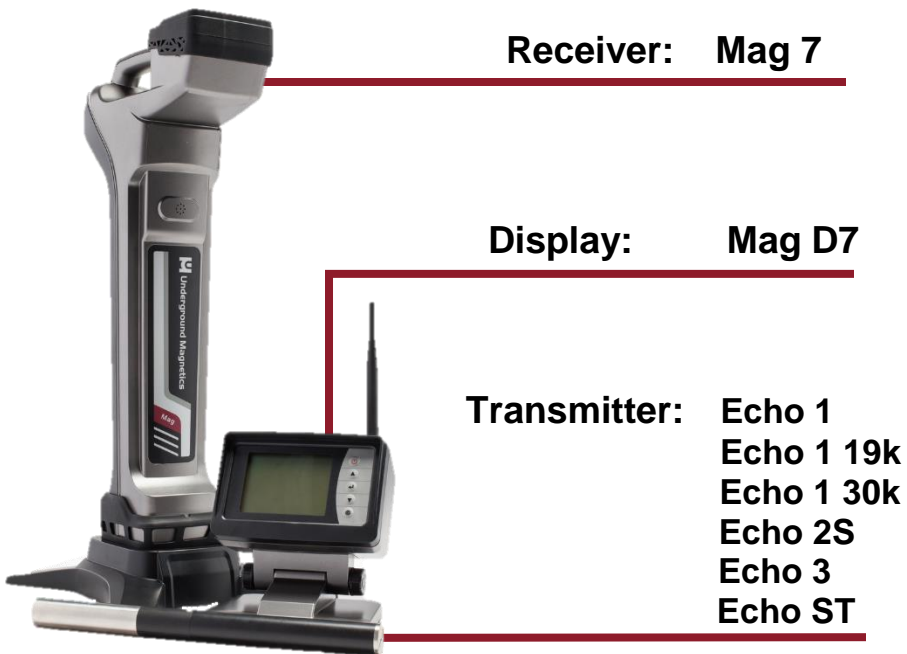

7: Receiver





7.1: Specifications



Mag 7

System frequency	4kHz, 19kHz, 30kHz
Water resistant	IP65
Temperature range	-20° to 60°C
Telemetry	4 radio channels with range up to 900 meters
Rechargeable lithium battery	12.5V
Battery life	Up to 50 hours
Dimensions	68 x 13 x 30 cm
Weight	3 kg

7.2: Receiver Operation

-  **Power key:** Press and hold to turn on or off. Tap to turn backlight on or off.
-  **Up key:** Move to previous cursor selection.
-  **Down key:** Move to next cursor selection.
-  **Confirm key:** Tap to confirm cursor selection. Press and hold to enter secondary page. Tap from main page to enter Bore-To mode.
-  **Setup key:** Tap to enter calibration page/ return to main page. Press and hold to enter setup page.

7.3: Icons

7.3.1: Main Page Icons

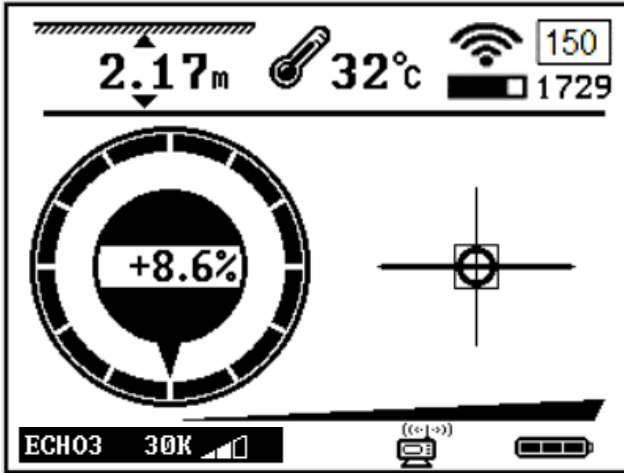

ECH03 30K

- Transmitter model, frequency, and power

1729

- Transmitter signal strength



- Signal to noise ratio bar



- Transmitter battery status



- Transmitter temperature (Flashing indicates transmitter is over-heating)



- Receiver and display connection status

2.17m

- Distance between transmitter and receiver

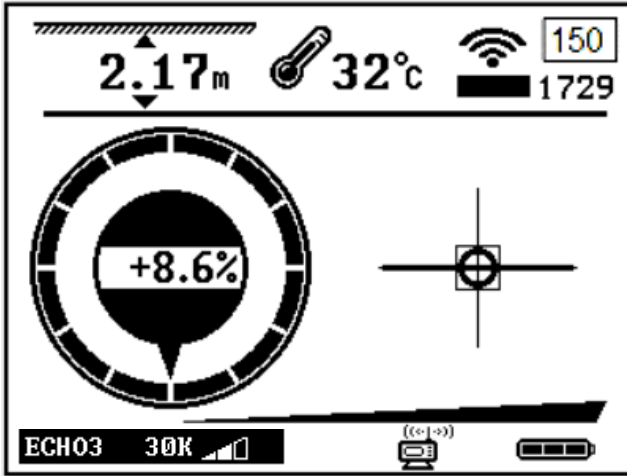

+8.6% • Transmitter pitch



• Roll indicator



• 24 clock positions



• Receiver position



• Locate Line



• Locate Point

7.3.2: Secondary Page Icons

To enter the Secondary Page, press and hold 

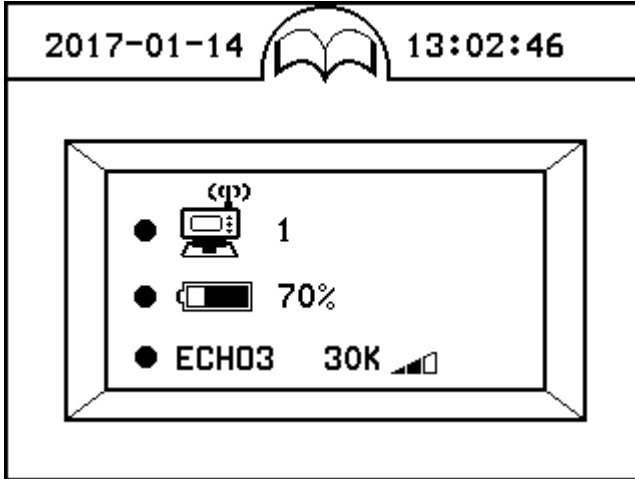

ECH03 30K  Transmitter model, frequency, and power

 **70%** Receiver battery status

 **1** Radio channel

7.3.3: Calibration and Depth Forecast Page Icons

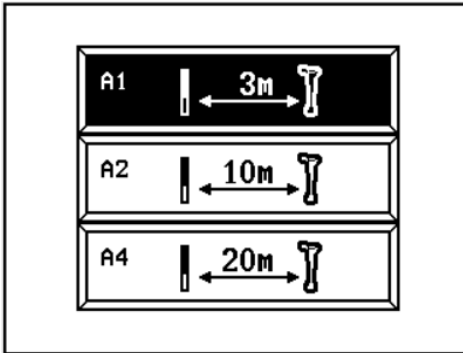

- A1: 3m calibration
- A2: 10m calibration
- A4: 20m calibration

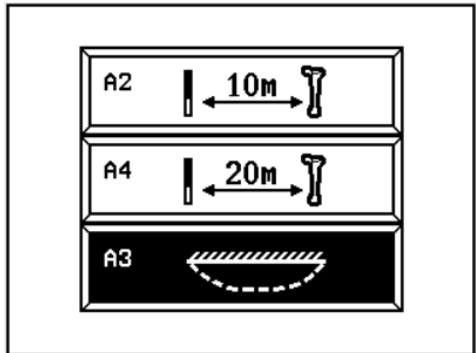

- A1: Depth forecasting

7.3.4: Setup Page Icons

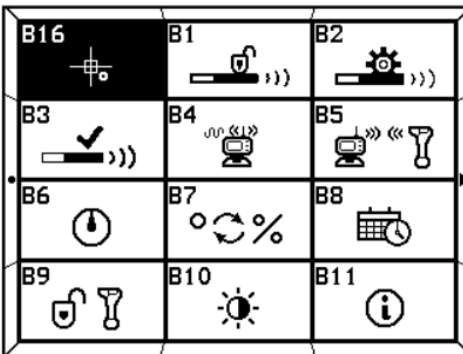

- B1: Transmitter activation
- B2: Transmitter settings
- B3: Receiver settings
- B4: Radio channel selection
- B5: Receiver and display pairing
- B6: Roll calibration
- B7: Pitch unit selection
- B8: Time setting
- B9: System lock/unlock
- B10: Visibility control
- B11: System info
- B16: Speed Control



7.4: Calibration

7.4.1: Depth Calibration (3 meters, 10 meters, or 20 meters)

Warning: Even if the transmitter's roll, pitch, battery status and temperature are displayed correctly, calibration may not be reliable due to a distorted magnetic field.

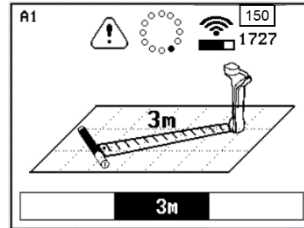
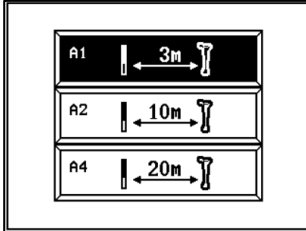
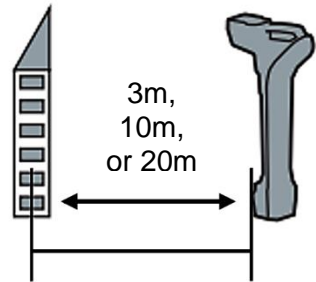
1. Make sure that the transmitter is working properly. Place it in the housing.
2. Place housing containing the transmitter in a location away from interference.
3. Set transmitter and receiver desired distance apart from center of transmitter to inside edge of receiver's base, as shown.



4. Tap  to enter Calibration Page and tap  to highlight desired distance.

5. Tap  three times to start calibration and wait for calibration to complete.

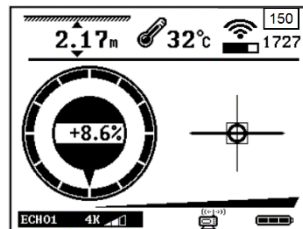
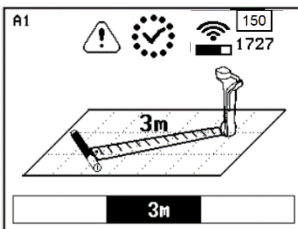



7. Calibration complete.
8. Tap  to return to Main Page.

7.4.2: Roll Calibration

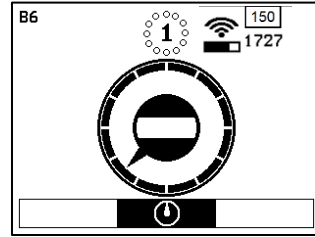
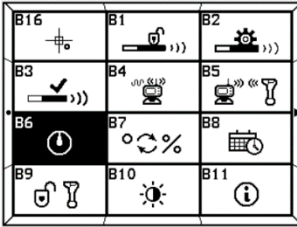
1. Place transmitter housing in a 12 o'clock position.



2. Press and hold  to enter Setup page and tap  to select B6 icon.
3. Tap  three times to enter and start roll calibration and wait for calibration to complete.

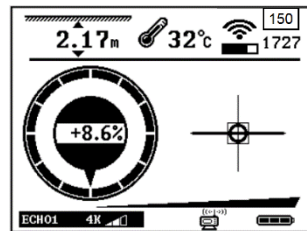
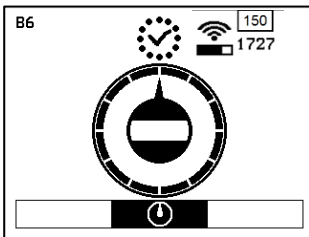

4. Calibration complete.
5. Tap  to return to Main Page.

7.5: Operation

7.5.1: Depth Forecast

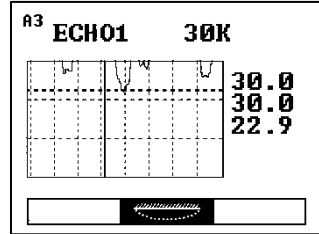
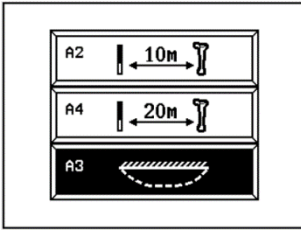

1. Tap to enter calibration page and tap to select A3 icon.

2. Tap to enter Depth Forecast Page. Best case, average, and worst-case depth forecast values are listed on the right while transmitter model and frequency are listed at the top. Tap to reset forecast.

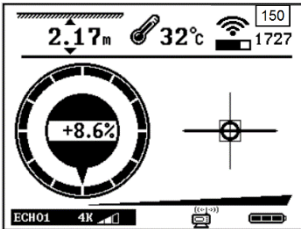

3. Tap to return to Main Page.

Note: The best-case depth forecast value is a conservative value and will be the main value used when determining interference.

Using Depth Forecast

Before installing the batteries into the transmitter, it is important to walk the bore path while gauging interference. This will allow you to determine which frequency is the most appropriate to use while drilling.

Walk the bore path with each frequency selected and make note of the best case depth forecast values.



Page 18



Compare these values against the expected values for each frequency to gauge interference type and level. The greater the difference between the two values, the more interference there is.

Frequency	Expected Best Case Value- Echo 1	Appropriate Drilling Scenarios
4 kHz	90'	Passive interference
19 kHz	130'	Common case
30 kHz	130'	Active interference

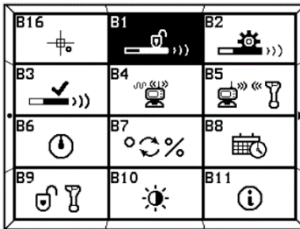

7.5.2: Transmitter Activation (For dealer or factory use)

(Process must be started within 10 minutes after batteries have been placed in the transmitter.)

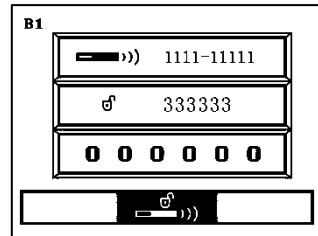

1. Press and hold  to enter Setup Page. Tap  to highlight the B1 icon and then tap  to enter Transmitter Activation Page.



2. 1111-1111 is the transmitter identification number and 3333-3333 is the prompt code in the diagram. Send the transmitter identification number and the prompt code to the dealer. The dealer will give you an activation password. Use  and  to input password, tap  to confirm activation.

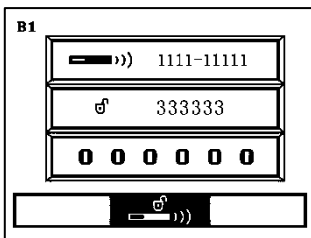





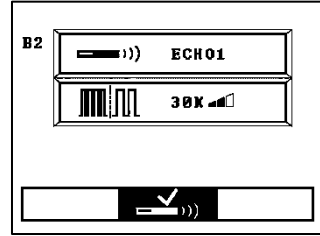
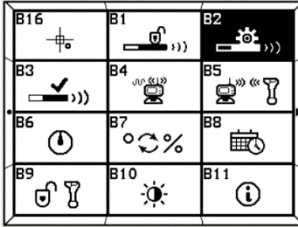

3. Tap  to return to Main Page.

7.5.3: Transmitter Settings

(Process must be started within 10 minutes after batteries have been placed in the transmitter.)



1. Press and hold  to enter Setup Page and tap  to select B2 icon.
2. Tap  to enter Transmitter Settings Page. The receiver and Echo transmitter will automatically pair. Then tap  or  and  to select frequency and power level.

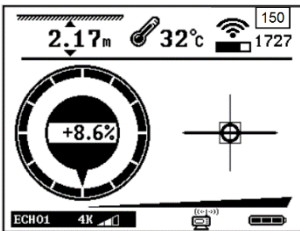

3. Tap  to return to Main Page.

7.5.4: Receiver Settings

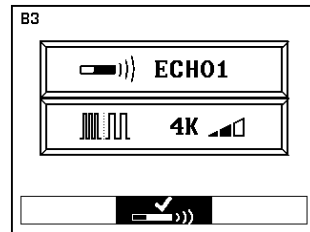
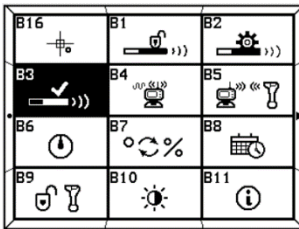



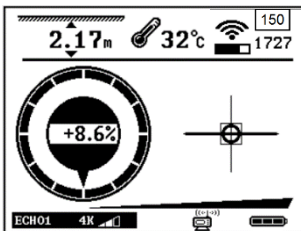



1. Press and hold to enter Setup Page. Tap to select B3 icon.
2. Tap to enter Receiver Settings Page. Tap or and to select transmitter model, frequency, and power.

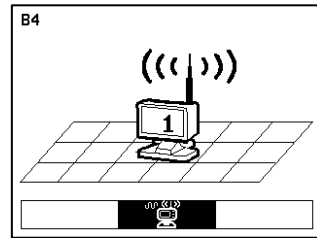
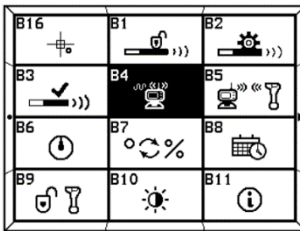

3. Tap to return to Main Page.

7.5.5: Radio Channel Selection



1. Press and hold  to enter Setup Page. Tap  to select B4 icon.
2. Tap  to enter Radio Channel Page. Use  or  to select radio channel.

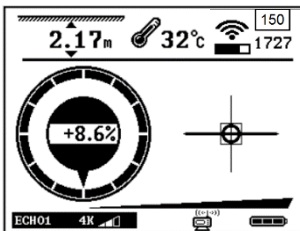

3. Tap  to return to Main Page.

7.5.6: Pairing

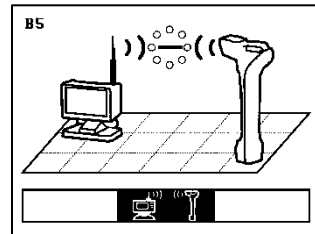
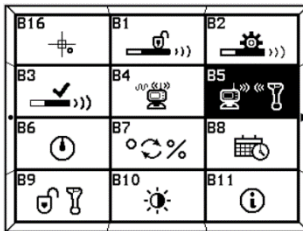

1. Press and hold to enter Setup Page. Tap to select B5 icon.
2. Tap to enter Pairing Page. Tap to start pairing. (It is required that these last two steps are performed on the display at the same time.)

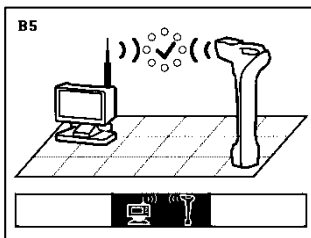



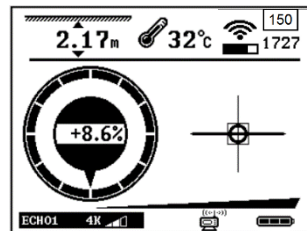

3. Pairing complete.
4. Tap to return to Main Page.

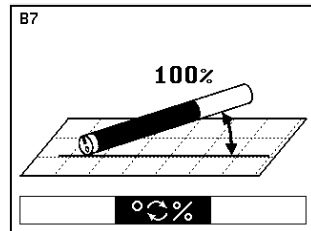
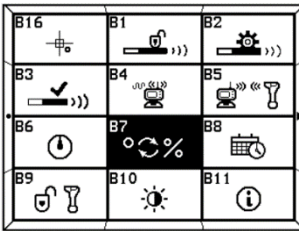

7.5.7: Pitch Unit Selection





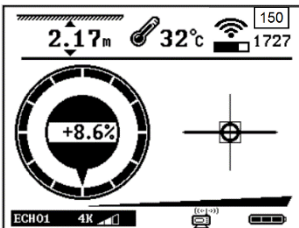



1. Press and hold  to enter Setup Page and tap  to select B7 icon. Tap  to enter Pitch Unit Selection Page.
2. Tap  to switch pitch mode.

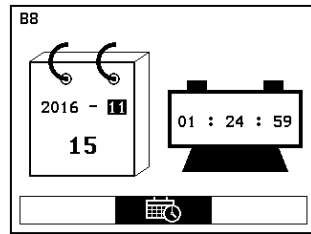
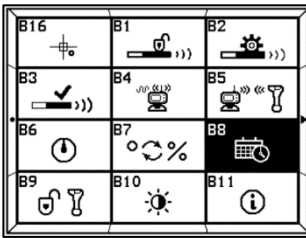

3. Tap  to return to Main Page.

7.5.8: Time Setting (For dealer or factory use)



1. Press and hold  to enter Setup Page. Tap  to select B8 icon.
2. Tap  to enter Time Settings Page. Tap  to select year, month, day, hour, or minute. Tap  or  to set time.

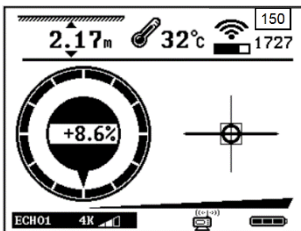

3. Tap  to return to Main Page.

7.5.10: System Unlock (For dealer or factory use)

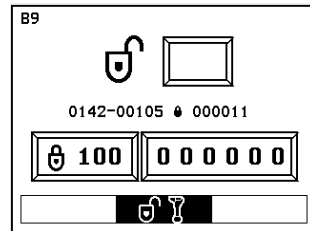
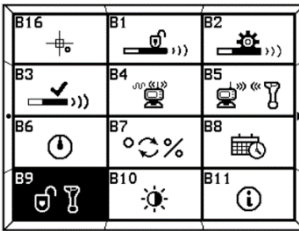



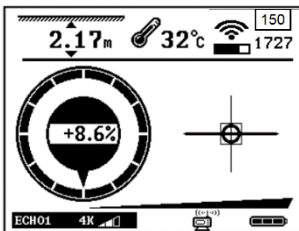



1. Press and hold to enter Setup Page and tap to select B9 icon. Tap to enter System Unlock Page.
2. Tap or and to input password.

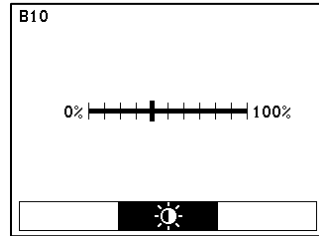
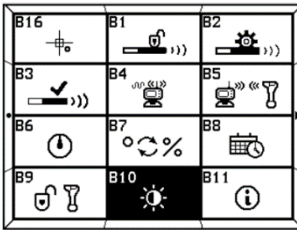

4. Tap to return to Main Page.



7.5.11: Visibility Control

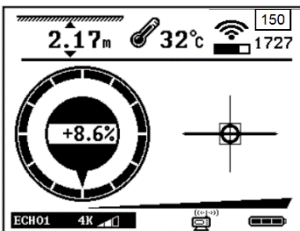

1. Press and hold  to enter Setup Page and tap  to select the B10 icon. Tap  to enter Visibility Control.
2. Tap  and  to adjust.



3. Tap  to return to Main Page.

Note: By holding both  and  at the same time while turning the receiver on, the visibility control will reset to normal visibility.

7.5.12: Speed Control

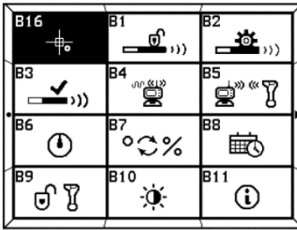

2. Press and hold to enter Setup Page and tap to enter the Speed Control Page.

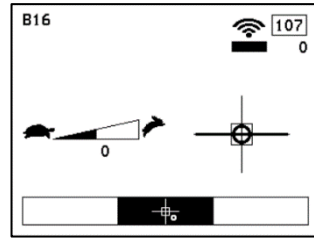

3. Tap and to adjust speed.

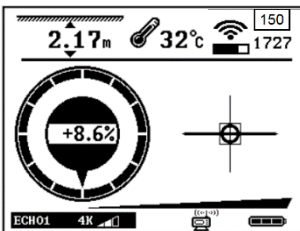

4. Tap to return to Main Page.

Note: Adjusting the speed control allows operators to more easily place the ball in the box when at very deep depths.

7.6: Receiver Maintenance

- The receiver uses rechargeable lithium batteries. The receiver will automatically shut off if no key is pressed for over a period of 20 minutes or if there is no information received from the transmitter. It is strongly recommended that the batteries are taken out of the receiver if it is not being used for a long period of time to avoid potential corrosion.
- The receiver is an electronic measurement device. Severe shock and impact can damage the housing and the electronics inside the housing.
- Keep the receiver away from excessive heat to avoid damages to the plastic housing and the electronics inside the housing.
- Do not soak the receiver in excessive amounts of water.



8 Display





8.1: Display Specifications

Mag D7



Radio frequency	915MHz
Water resistant	IP65
Temperature range	-20° to 60°C
Telemetry	4 radio channels with range up to 900 meters
Power	Rechargeable lithium batteries
Battery life	Up to 50 hours
Screen	Industrial rated LCD graphic display
Dimensions	19 x 13 x 19 cm
Weight	1.5 kg

8.2: Display Operations

-  Power key: Press and hold to turn on or off. Tap to select level of backlight.
-  Up key: Move to previous cursor selection.
-  Down key: Move to next cursor selection.
-  Confirm key: Tap to confirm cursor selection. Press and hold to enter secondary page.
-  Setup key: Tap to return to main page. Press and hold to enter setup page.

8.3: Icons

8.3.1: Main Page Icons

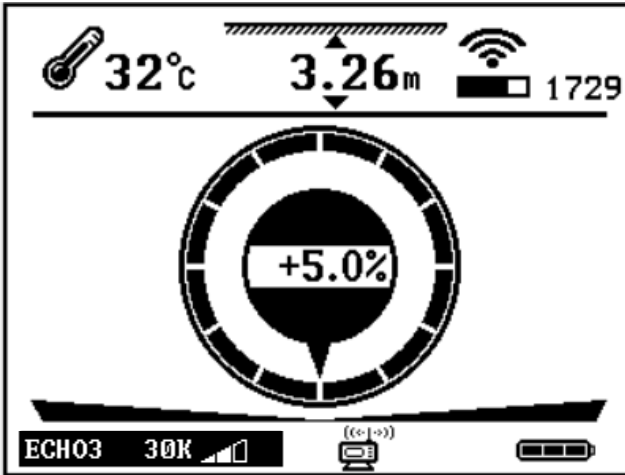

ECHO3 30K 

- Transmitter model and frequency

1729

- Transmitter signal strength



- Signal to noise ratio bar



- Transmitter battery status



- Transmitter temperature (Flashing indicates transmitter is over-heating)



- Receiver and display connection status



3.26m

- Distance between transmitter and receiver

+5.0%

- Transmitter pitch

8.3.2: Secondary Page Icons

To enter the Secondary Page, press and hold 

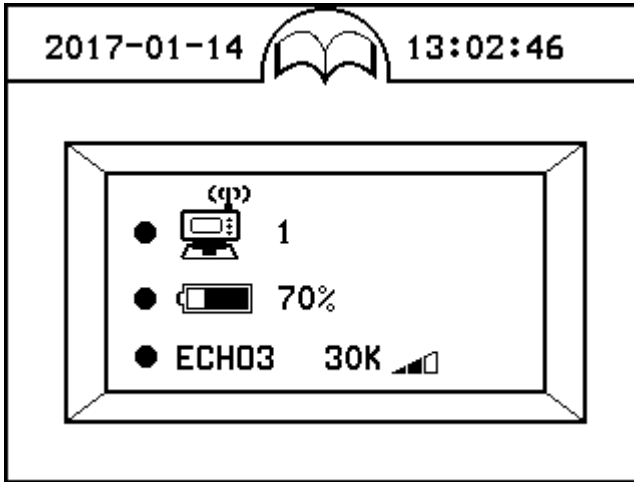

ECHO3 30K  Transmitter model, frequency, and power

 **70%** Receiver battery status

 **1** Radio channel

8.3.3: Setup Page Icons

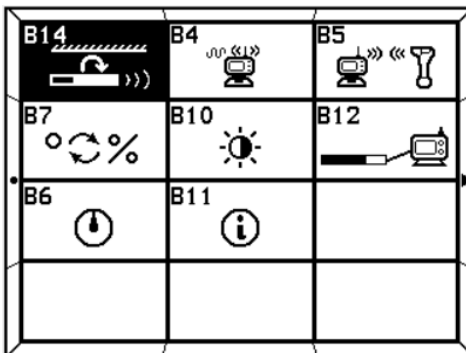

B4: Radio channel selection

B5: Receiver and display pairing

B7: Pitch unit selection

B10: Visibility control

B11: System info

B14: Down hole Echo mode change

8.3.4: Down Hole Echo Mode Change (Echo 2S and Echo 3)

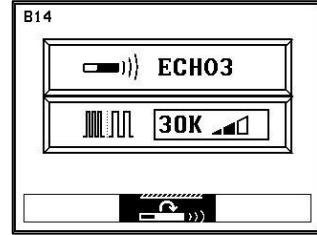
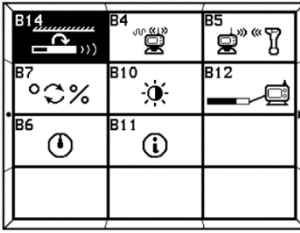

1. Press and hold to enter Setup Page. Tap to enter Down Hole Echo Mode Change Page.
2. Use or to select desired frequency and power levels. Tap to begin mode change process.

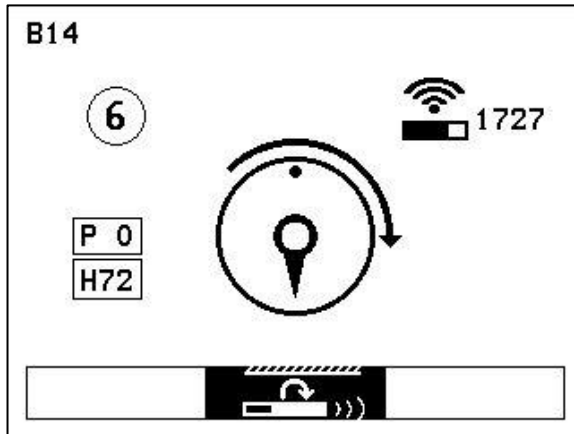

Roll indicator



Steps remaining



Target dot



Instructions



Hold: hold this roll position until it counts down to 0



Proceed: time left to proceed in process by rotating to new roll position in sequence

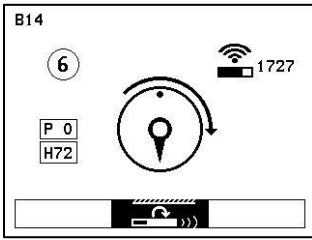

Rotate drill head until roll indicator points toward target dot. Instructions will change from the clockwise arrow to “STOP”.

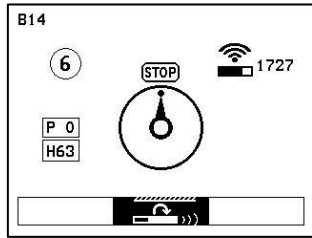

Hold this position until “H” counts down to 0.

Rotate drill head to next position in sequence before “P” counts down to 0 or the sequence will be canceled.

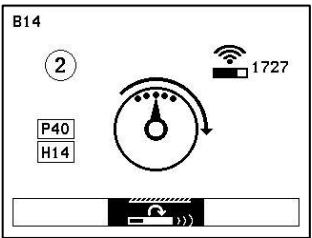

If the next step has the target dots in the same place as the previous step, rotate the drill head one entire rotation until the roll indicator lines up with the target dots again.

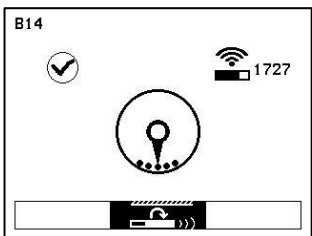
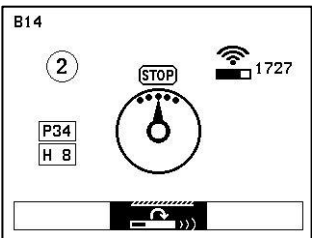





Once all six steps of the sequence are complete, change the Transmitter Settings on the receiver to match the new frequency and power levels.

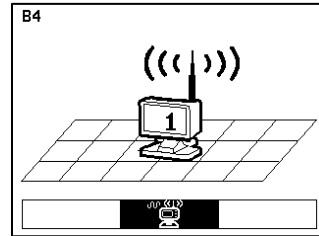
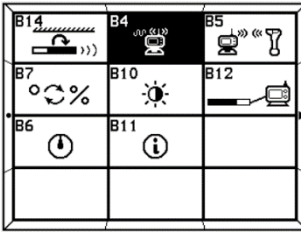

Page 18

8.3.5: Radio Channel Selection





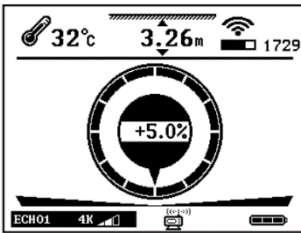

1. Press and hold  to enter Setup Page. Tap  to highlight B4 and tap  to enter Radio Channel Page.
2. Use  to select radio channel.



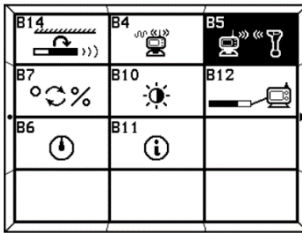

3. Tap  to return to Main Page.

8.3.6: Pairing

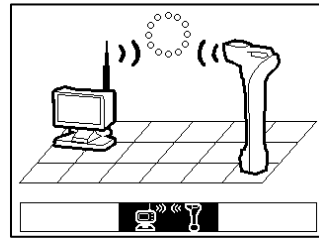

1. Press and hold  to enter Setup Page and tap  to select B5 icon. Tap  to enter Radio Registration Page.



2. Tap  to start pairing. (It is required that the following procedure is performed on the receiver at the same time)

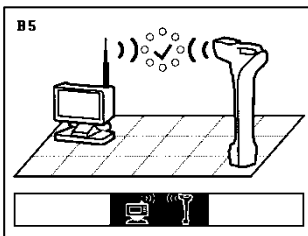



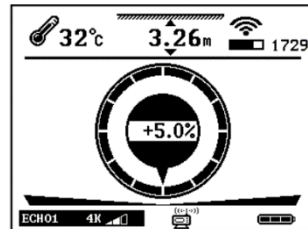

3. Pairing complete.

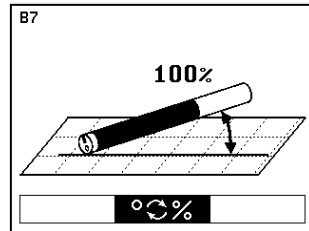
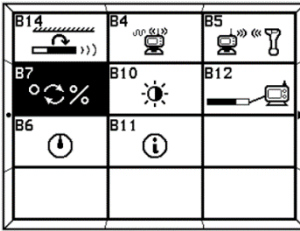

4. Tap  to return to Main Page.

8.3.7: Pitch Unit Selection





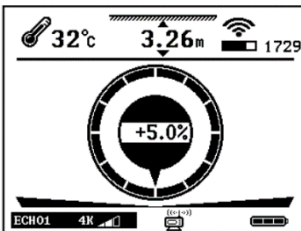



1. Press and hold  to enter Setup Page and tap  to select B7 icon. Tap  to enter Pitch Unit Selection Page.
2. Tap  to switch pitch mode.

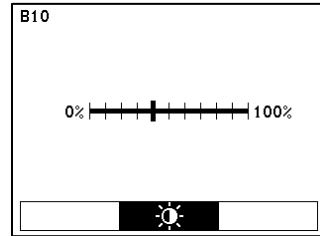
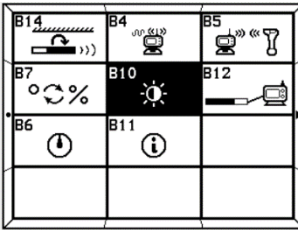

3. Tap  to return to Main Page.



8.3.8: Visibility Control

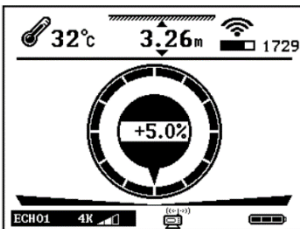

3. Press and hold  to enter Setup Page and tap  to select the B10 icon. Tap  to enter Visibility Control Page.
4. Tap  and  to adjust.



5. Tap  to return to Main Page.

Note: By holding both  and  at the same time while turning the receiver on, the visibility control will reset to normal visibility.

8.4: Display Maintenance

- The display uses rechargeable lithium batteries. The display will automatically shut off if no key is pressed for over a period of 20 minutes or if there is no information received from the receiver. It is strongly recommended that the batteries are taken out of the display if it is not being used for a long period of time to avoid potential corrosion.
- The display is an electronic measurement device. Severe shock and impact can damage the housing and the electronics inside the housing.
- Keep the display away from excessive heat to avoid damages to the plastic housing and electronics inside the housing.
- Do not submerge the display in excessive amounts of water.

9: Transmitter

9.1: Introduction

The transmitter provides drill head temperature, clock position, pitch, battery status and locating signal. The transmitter transmits signals at 4 kHz, 19 kHz or 30 kHz. The transmitter will enter a “sleep” mode after 15 minutes without rotation. It takes 10 seconds to “wake up” once the transmitter is rotated.

Note: If drilling in adverse soil conditions (i.e. rock), normal C cell batteries will experience battery chatter. This can greatly reduce battery life. To prevent this, use your provided double C lithium cell battery instead.

8.2: Specifications

Echo 1

Weight	0.7 kg	
Dimensions	3.2 x 38 cm length	
Frequency	4kHz/19kHz/30kHz	
Depth Range	27.5 / 40 / 40 meters	
Power	2 C cells, Echo Cell Kit, or Lithium Battery	
	C cell	3V, 12 hours of continuous usage
	Echo Cell Kit	3V, 20 hours of continuous usage
	Lithium*	3V, 48 hours of continuous usage
Roll	24 transmitter roll positions	
Pitch	0.1% resolution	
Temperature	Under 87.7°C	

Echo 2S



Weight	0.7 kg	
Dimensions	3.2 x 38 cm length	
Frequency	4kHz/19kHz/30kHz	
Depth Range	27.5 / 40 / 40 meters	
Power	Echo Cell Kit or Lithium Battery	
	Echo Cell Kit	3V, 20 hours of continuous usage
	Lithium*	3V, 48 hours of continuous usage
Roll	24 transmitter roll positions	
Pitch	0.1% resolution	
Temperature	Under 87.7°C	
High Power Modes	<ul style="list-style-type: none"> • 19kHz and 30kHz depth range of 48.75 meters • Operating time is 5 hours for Echo Cell Kit and 12 hours for lithium battery 	
Down Hole Mode Change	Able	 <div style="border: 1px solid red; padding: 2px; display: inline-block;">Page 32</div>

Echo 3

Weight	1 kg	
Dimensions	3.2 x 48.25 cm length	
Frequency	4kHz/19kHz/30kHz	
Depth Range	27.5 / 40 / 40 meters	
Power	2 Echo Cell Kits or 2 Lithium Battery Packs	
	Echo Cell Kit	3V, 50 hours of continuous usage
	Lithium*	6V, 160 hours of continuous usage
Roll	24 transmitter roll positions	
Pitch	0.1% resolution	
Temperature	Under 87.7°C	
Power + Mode	<ul style="list-style-type: none"> • 19kHz and 30kHz depth range of 58 meters • Operating time is 12 hours for Echo Cell Kit and 40 hours for lithium batteries • Data update is slower but range is longer 	
Down Hole Mode Change	Able	 Page 32



Echo 1 19kHz



Weight	0.7 kg
Dimensions	3.2 x 38 cm length
Frequency	19kHz
Depth Range	40 meters
Power	2 C-cells 12 hours, Echo Cell Kit 20 hours, Lithium Battery Pack 48 hours
Roll	24 transmitter roll positions
Pitch	0.1% resolution
Temperature	Under 87.7°C

Echo 1 30kHz



Weight	0.7 kg
Dimensions	3.2 x 38 cm length
Frequency	30kHz
Depth Range	40 meters
Power	2 C-cells 12 hours, Echo Cell Kit 20 hours, Lithium Battery Pack 48 hours
Roll	24 transmitter roll positions
Pitch	0.1% resolution
Temperature	Under 87.7°C

Echo ST



Weight	0.25 kg
Dimensions	2.4 x 15.25 cm length
Frequency	30kHz
Depth Range	18 meters
Power	1 3V lithium battery
Roll	24 transmitter roll positions
Pitch	0.1% resolution
Temperature	Under 87.7°C

9.3: Digital Information

- Pitch: From -100% to +100% with 0.1% resolution within the range of -45% to +45% and 1.0% resolution outside of that range.
- Roll: 24 transmitter roll positions
- Battery: **Install batteries positive side down and install battery cap with provided battery cap tool.**
 - C cell: Battery full, 2/3 full, 1/3 full and flash warning
 - Lithium: Will show battery full then flash warning
- Temperature: When the transmitter is overheating, temperature indication in the receiver's display flashes. If temperature reaches over 87.7°C (190°F), transmitter may be permanently damaged. If this happens, the dot temperature indicator on the front of transmitter will turn black.

9.4: Transmitter Maintenance

- Do not place the transmitter near excessive temperature (over 190°F/87.7°C).
- Do not apply excessive pressure, shock or vibration on the transmitter.
- Take the battery out of the transmitter after use.
- Clean the spring and cap on the battery compartment when necessary.
- Regularly check the sealing ring on the battery cover. Replace if necessary.

10: Locating Methods

One major advantage of the Mag 7 system is its simplicity. Once the receiver and transmitter are paired, the operator is not required to push any buttons to pinpoint the location, direction or depth of the transmitter.

10.1: Locating Basics

10.1.1: Locate Points and Locate Line

The Mag 7 receiver locates the transmitter by pinpointing three specific locations along the transmitter's magnetic field. The front locate point (FLP) ahead of the transmitter, the rear locate point (RLP) behind the transmitter and the locate line (LL) above the transmitter.

For the most accurate location and depth of the transmitter, both the FLP and the RLP should be located before locating the LL. The front and rear locate points, when lined up, indicate the exact direction of the transmitter. If the transmitter is level, the locate line will be located directly in-between the two points.

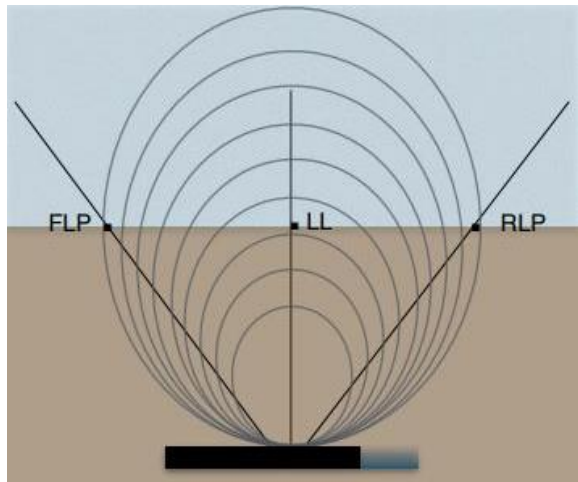

Side view

The Locate Line does not equal the location of the transmitter. The Locate Line extends left and right of the transmitter.

Think of the transmitter as an airplane. The FLP is the nose and the RLP is the tail. You can locate the LL left and right of the body, but that is not the center of the transmitter.

This is why you must locate both the FLP and RLP before the LL to get the most accurate depth and location.

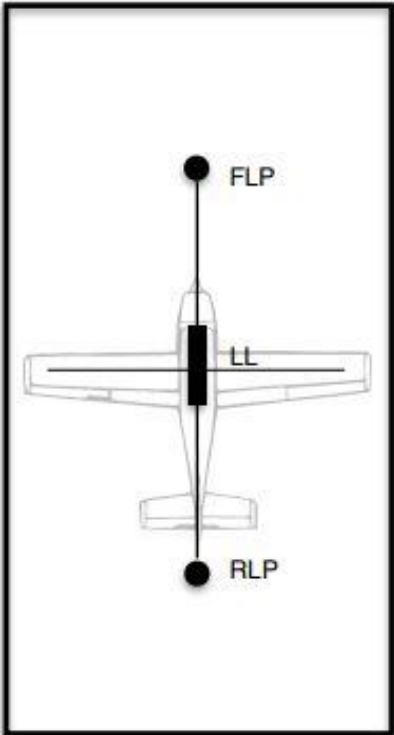

Top view

10.1.2: Finding the Front Locate Point

Scenario:

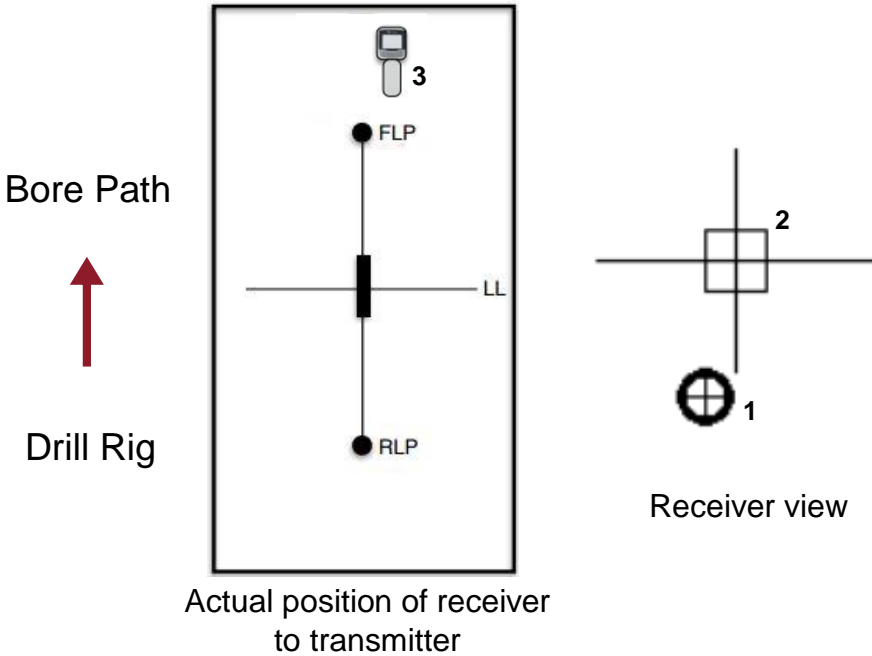

The locating procedure described here assumes you are (a) facing away from the drill rig, toward the bore path, (b) the transmitter is below ground and between you and the drill rig and (c) the FLP is behind you.

The locate point (LP) indicator, known as the **ball**, in the receiver view (1) shows that the nearest LP (which in this case is the FLP) is behind you (2).

Steps to locate FLP

1. Move the receiver (3) back toward the drill (which is behind you) and walk to the left or right until the ball moves into the receiver indicator (the **box** with crosshairs). You are now at the FLP. Mark the location on the ground.

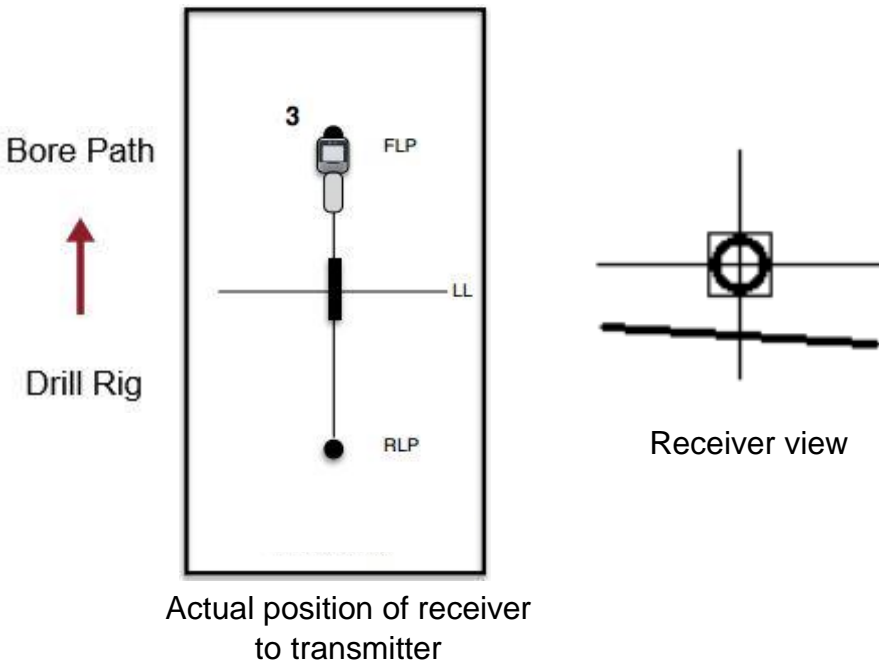

2. Notice the position of the Locate Line. This confirms that you have just located the FLP and that the RLP is behind you.

10.1.3: Finding the Rear Locate Point

Steps to locate RLP

1. Move the receiver (3) back toward the drill until the LL crosses the box and the ball moves off screen. A new ball will appear at the bottom of the screen. This is your RLP.

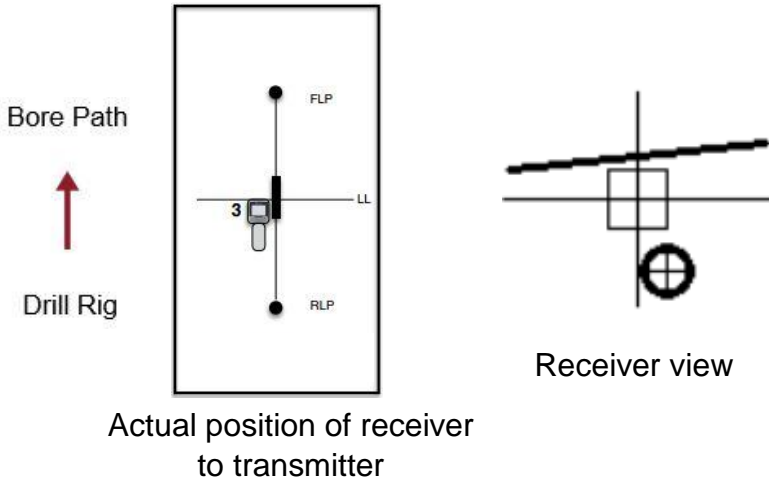

2. Move the receiver back toward the drill and move to the left or right until the ball is in the box. You are now over the RLP. Mark the ground.

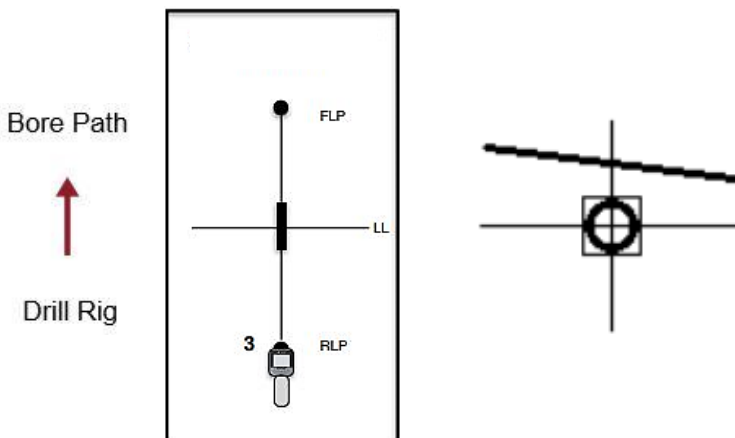

10.1.4: Finding the Locate Line and Transmitter

Now that the FLP and RLP have been marked, you're ready to locate the transmitter.

Steps to Locate LL

1. From the RLP walk toward the FLP. The LL will start to center as shown on the receiver view below.

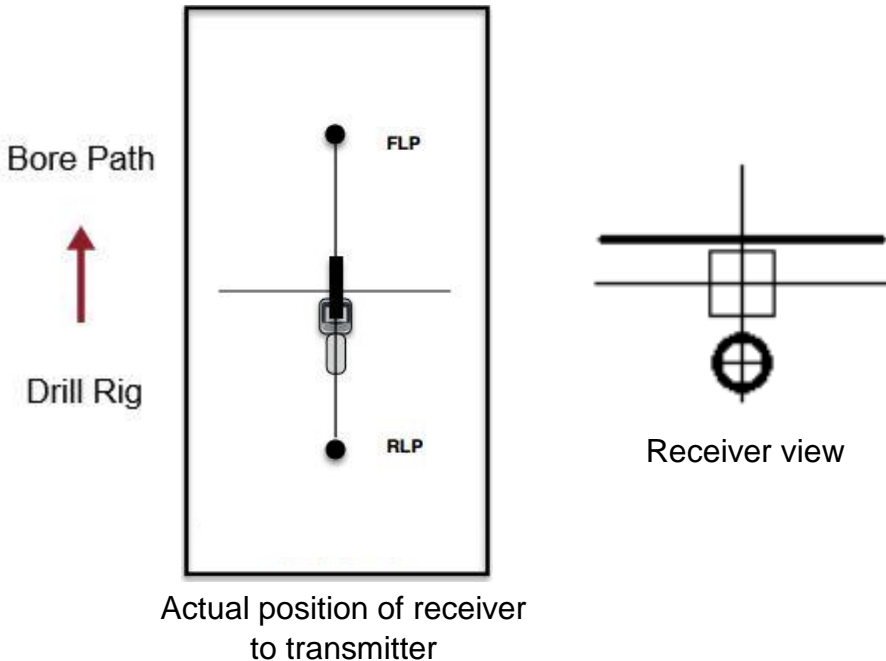

2. Once the LL is centered as shown below, you are directly over the head and you may mark the location and note depth.

(Note: the left-right bar should not be used over the head)

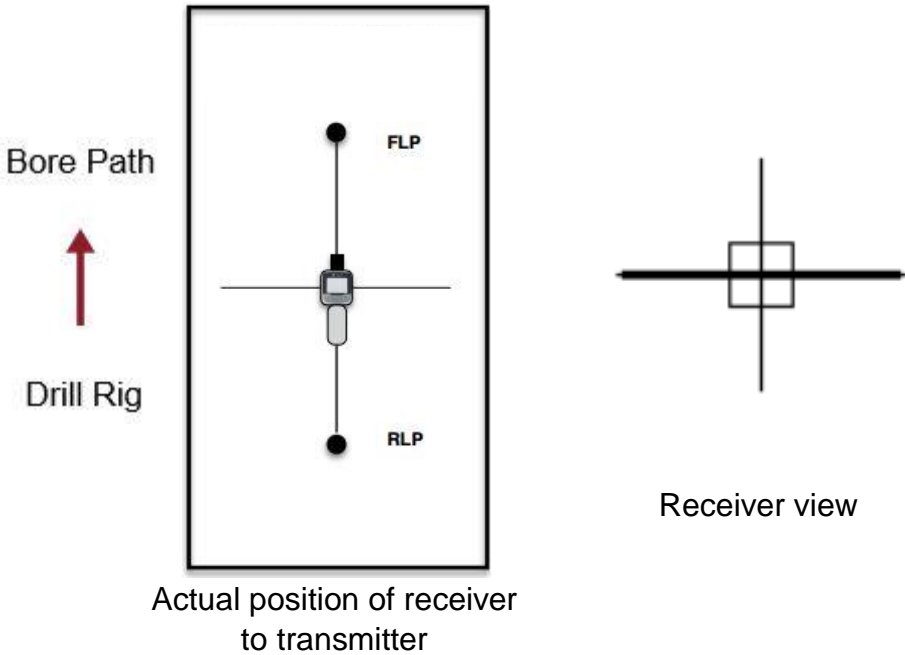

10.2: Tracking on the Fly

Tracking on the fly may be used once the bore path is established and level. This tracking method will increase locating speed and in turn the speed at which the bore can be completed.

As long as the FLP remains on target, there is no need to find the RLP on every rod. If steering is required, a quick look at both the RLP and the FLP will ensure the transmitter is still on target.

While tracking on the fly using 3m drill pipes the operator should walk forward from the last FLP approximately 3 meters and place the receiver down in line with the path created by the RLP and the FLP. While the drill operator is drilling toward the receiver, wait for the arrow to ball to go into the box. Once it does, mark the new FLP. Now simply walk back to the LL being careful to stay in line with your last FLP and mark the new location of the transmitter and record the depth.

Refer to diagram on the next page.

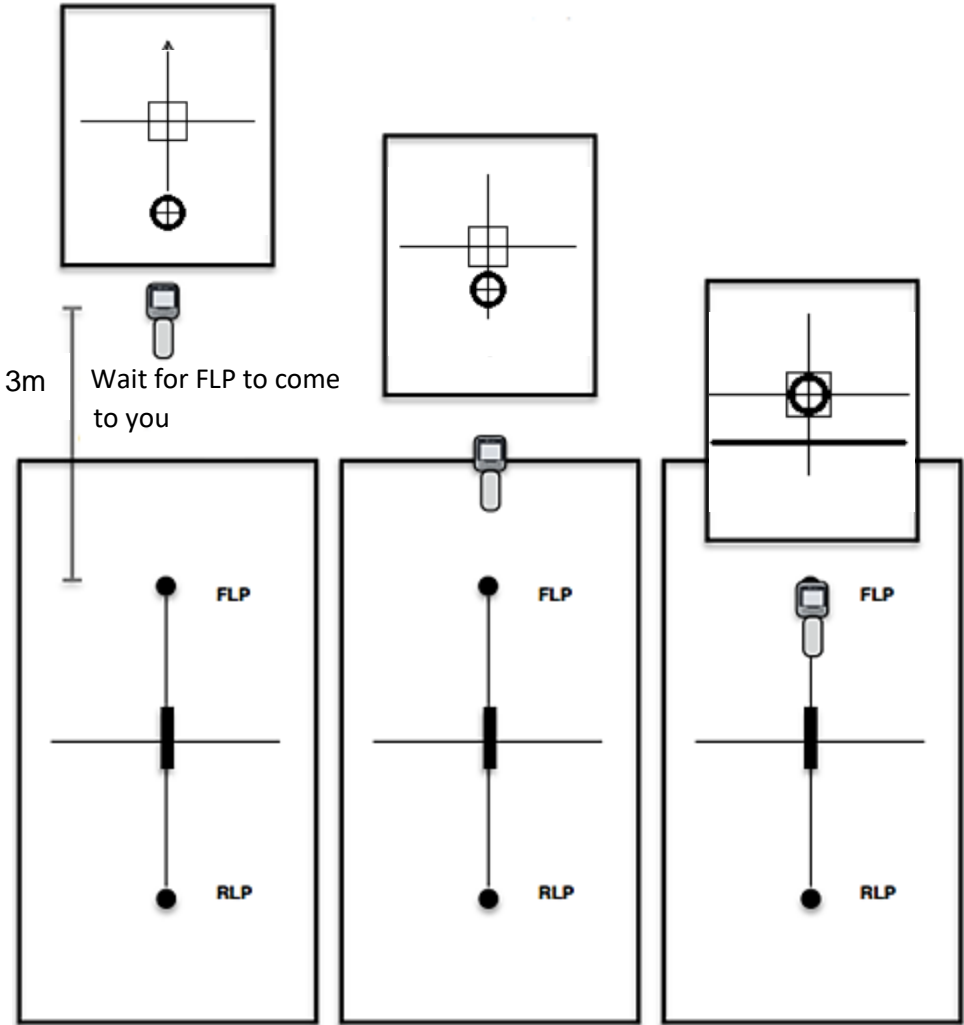

10.3: Bore-To

To switch the receiver to Bore-To mode, tap the  from the main page.

To return to Walkover mode, simply tap  again.

The display screen on both the receiver and the remote display will look like the screen to the right.

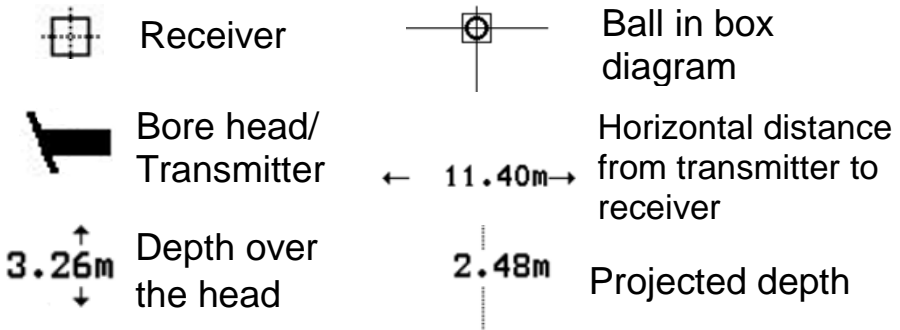
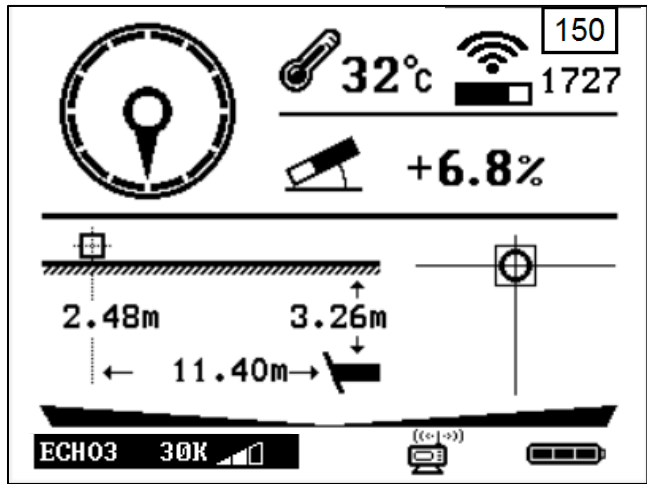

Projected Depth

Projected depth tells you what depth the head will be at when it reaches the receiver if the operator maintains the indicated pitch.

The Bore-To feature on the Mag 7 is very powerful. Operators can expect to receive good right-left steering, pitch, and roll information as far out as 30 meters.

It is important to note that the depth is only a reference and is not accurate. As depth between the transmitter and receiver decreases, the accuracy increases.

For accurate depth, the operator should verify by walking over the transmitter.

For best Bore-To results, the operator should locate up to the area that can't be walked over and mark both the FLP and RLP* before moving the receiver to the other side.

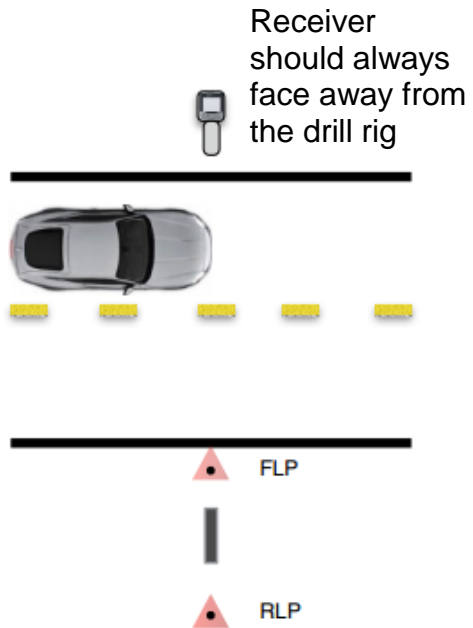

Once on the other side, place the receiver directly in-line and proceed with drilling using the ball and box to keep the bore path in-line.

*It is best to place an object, like a traffic cone, at both the front and rear locate points so that a visual alignment can be viewed.

11: Battery and Charger

- Mag receivers use lithium rechargeable batteries.
- This lithium rechargeable battery comes with a special charger. Any use of other lithium rechargeable battery or charger for the receiver may cause fire, explosion, leaking or other damages.
- Store the battery at the room temperatures; 15-25°C (59-77°F). Extreme high or low temperatures will shorten the battery life.
 - Do not submerge the battery in water or any other liquids.
 - Do not throw the battery into fire.
 - Do not disassemble the battery.
 - Avoid any kind of damage to the battery.
 - Please dispose of lithium properly.
- When charging the battery, the red light will shine. When charging is complete, a green light will shine.

12: Warranty

Underground Magnetics offers standard warranty on parts and labor of the Mag 7 series locating system under normal usage. The warranty period is one year for the receiver and display and one year for the transmitter. Warranty time is from the date of transaction.



Underground Magnetics

www.undergroundmagnetics.com